

A

Schematic Genomic Structure of *trx-1*

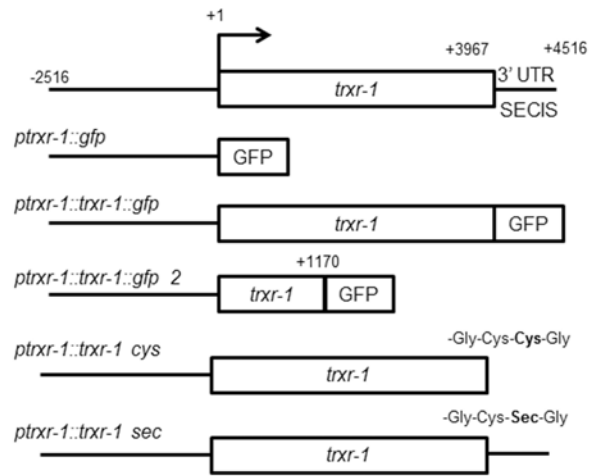

B

Schematic Genomic Structure of the Operon Containing of *trx-2*

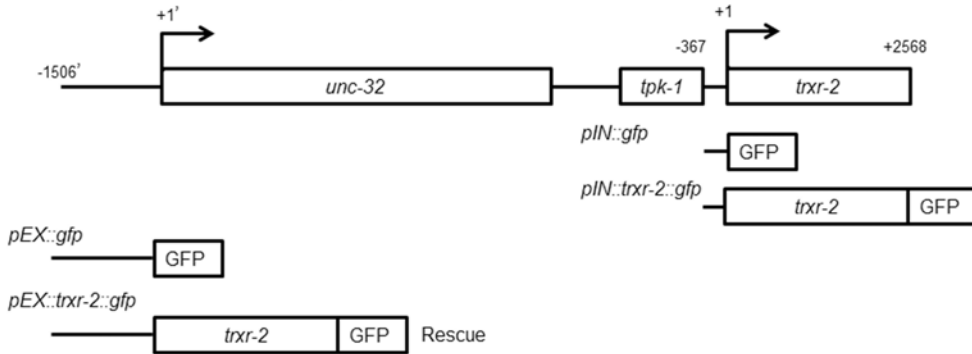

A

Celegans : MKSLTEIFGCEFKRQESQCEASSPANPHVSDTILSMGVAASGMPPPKRRPAPAESITLPGETLVDAEGIPLKEALKEAANSKIVIFYNSDEEEKQLVEFETYI : 100
 Fruitfly : ---MNTICNSRFSVTFVRQCSTILTSPSAGIIONRGSILT-----TKVPHWISSSSCAHHTFQRTMNLTGQRGSRDSTGAAAGN----- : 75
 Mouse : ---MFDVDDCWLIFPASPGRIFVQCVVWVAPTCPNCCWFFPGLPE---VPRPEHVP-RVILRGE---EGAVLPASRPSKTLPSSSQTP---CPTDPCF : 83
 Human : ----- : -----

Celegans : NSLKEPADAEKLEIPEMKKLVQVSRASQKVIQYLTHHSWPLMYEKENAVGGLKELKALKQDYLKEWLRDHTYDLIVIGGSSGGLAAAKEASRLGKRVAC : 200
 Fruitfly : APAGSGAGAPPE----FQHPHCDRAAMYAQPVRKMSIKG-----GSYDYLIVIGGSSGGLCAKEAVLNCAQVAC : 142
 Mouse : CPPPSTPDSRQ-----EKNTQSELPNKKGQLQKIPQ-----MNC-----SKDPPGSDYFDLIIIGGSSGGLAAAKEAAKFDKRVLV : 154
 Human : -----MNC-----PEDLPKSYDYDLIIIGGSSGGLAAAKEAAQYCKKVMV : 40

Celegans : LDFVVPSE-CGTSWGLGGTCVNVGCI PKKLMHQASLLGHSVHDAKKYGWKIPEGRVPEQWNHTRDSVQDHIASLNWGYRVCLSEKLVTVYINSVGEPTGEF : 299
 Fruitfly : LDFVVPSE-CGTSWGLGGTCVNVGCI PKKLMHQASLLGSAVHEAARYGWNV-DEKIRFQWPKLVQSVQNHKSVNWRVTRVLLRKKVVEYINGLGSFVDSF : 241
 Mouse : LDFVVPSE-LGTRWGLGGTCVNVGCI PKKLMHQARLLGQAQKLSRNYGWVW-BDTVKHDEKMTSESVCQSHIGSLNWEYRVLLREKRVVYENAMGRFVGF : 252
 Human : LDFVVPSE-LGTRWGLGGTCVNVGCI PKKLMHQARLLGQAQKLSRNYGWVW-BDTVKHDEKMTSESVCQSHIGSLNWEYRVLLREKRVVYENAMGRFVGF : 138
 AAAAAA

Celegans : EHSATNKKRVEKLTADRFLHSGURPKYPEIPGVKEYTMTSDDLECLPNSPGKTLQVGSYVSLCAGFLHGHGFVTVMVRVSI LLRGFDQMMARIRK : 399
 Fruitfly : TLAKLKSG-ERTITACIFVIVGCRPRYPPIPGAVEYGITSDLLFSLDRBPGKTLVVGAGYICLEAGFLKGLGYEFTVMVRSIVLRGFDQMMALVAA : 340
 Mouse : EIVATNKKGKEKIVSAERFLIATGSRPRYLCPGDKKEYCISDDLLFSLPYCPGKTLVVGASVYVLEAGFLAGGLDVTVMVRSIV LLRGFDQMMANKIGE : 352
 Human : EIRATNKKGKEKIVSAERFLIATGSRPRYLCPGDKKEYCISDDLLFSLPYCPGKTLVVGASVYVLEAGFLAGGLDVTVMVRSIV LLRGFDQMMANKIGE : 238

Celegans : HMIAYGMKHEAG-VPTSTEQIDEKIDEKAGRYVFWPKKNEBTGEMQEVSEPYNTILMAIGSEVVIDVGHITIGVES-AKSRKVLCSRECSHTIPVVA : 497
 Fruitfly : SMEERGIFFLRKTVLSVKQDDEK-----LIVKYKNVETG---EEADVYDVTVLAIGRKGVLDDILNPNAGVTV---QKDKIPVDSQDATTNVAIYA : 428
 Mouse : HMEELGKIFIRQEVETKIQEAGT---PGRIRVTAQSTNSEE---TIEGEFNTVLLAVGRBSCRTIGLETVGVKINEKTKIPVTEEECTNVPIYA : 445
 Human : HMEELGKIFIRQEVETKIQEAGT---PGRIRVTAQSTNSEE---TIEGEYNTVMLAIGRDACIRKIGLETVGVKINEKTKIPVTEEECTNVPIYA : 331

Celegans : IGDVLEGTIELTPVAIQAGSVIMSRIFLQANELTYDCIETTVFTPLEYGCCLSEEDAMMKYKQDNIMTYHNVNPELEYISESMERHCYIKNTICLGN : 597
 Fruitfly : VGDIIYCKIELTPVAIQAGRLARLLYGGSTQRMVYKVVATVFTPLEYAGVGLSEEDAVKCFGADIEVEFHGYRFFTEFEIQ-RSVRYCYLKNVAERH : 527
 Mouse : IGDILEGTIELTPVAIQAGRLARLLYGGSNVCKCYLNVFTVFTPLEYGCCLSEEDRAVEKFGEEINIEVYHSYFWELEWTVES-RENNHCYKILICNLK : 544
 Human : IGDILEDKVELTPVAIQAGRLARLLYGGSTVCKCYLNVFTVFTPLEYGCCLSEEDRAVEKFGEEINIEVYHSYFWELEWTVES-RENNHCYKILICNLK : 430

Celegans : EEKRVGGEHILTPNAGEVTCQGGIALKLAARKADFERLIGIHPTVAENFTLLIEKREGDEELQASGCUG : 667
 Fruitfly : GQQRVYGTIHYIGFVAGEVTCQGFALAKSGLIINTIINTVGIHPTTAEFTLRITIKRSGLDPTFASCCS- : 596
 Mouse : DDERVYGEHVLGFNAGEVTCQGFALAKCGLTKQCLDSIGIHVCAEFTLLSVTKRSGGDIICSG-ECUG : 613
 Human : DDERVYGEHVLGFNAGEVTCQGFALAKCGLTKKCLDSIGIHVCAEFTLLSVTKRSGASIIICG-- : 497

B

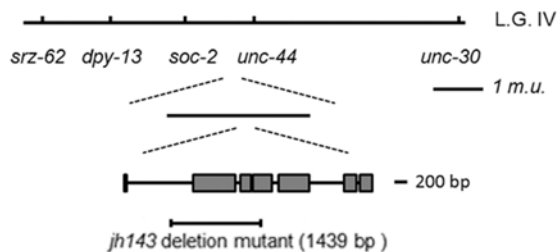

C

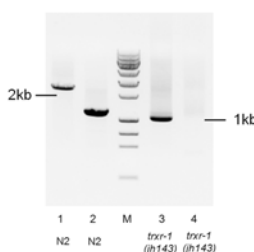

D

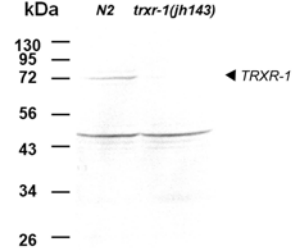

A

```

Celegans : -----MLLSTKRRHLPIIRLFSSN----- : 19
Fruitfly : MNLCSNRSFVTFVRQCSTILTSPPSAGIIQNRGSLTTKVPHWISSLSLSCDHHTEFCRTMNLTCQRCGRDSTGATCGNAPAGSGAGAPPPFQHPHCDRAAMYA : 100
Mouse : -----MVAAMVAATRGPSRRFRFPTRALIRGTRCAAS----- : 32
Human : -----MAAMVAALRGLGGRFRWRTCVAVAGGVRGAARG----- : 32

Celegans : -----KFDLLVIGGGSGGLSCSKRAADIGANVALILAVEPTF-HGHSWIGGGTCNVNGCIPKKLMHQAIVKRELRHADKYGWNIGIDCEKIK : 105
Fruitfly : QPVRKMSTKGGSYDYDLIVIGGGSGGLACRKEAVLNGARVACIDEVKPTFTLGTKWGVGGTCNVNGCIPKKLMHQAALLGEAWHEAAAYGWN--VDEKIK : 198
Mouse : -----AAGCCQSPDLLVIGGGSGGLCAKEAQLGKRVAVVDVVEPSP-RGTRKWGLGGTCNVNGCIPKKLMHQAALLGGLIQLDAPNYGWE--VACFPVQ : 122
Human : -----AAAGQRDYDLLVVGSGSGGLCAKEAQLGKRVAVVDVVEPSP-CGTRWGLGGTCNVNGCIPKKLMHQAALLGGLIQLDAPNYGWE--VACFPVQ : 122
          ▲
          AAAAAA

Celegans : HDWNVLSKNVNERVFRANNWIYRVOINCKKINYEAYEFVEKDKIVTCTTEKTKNFNLSAPNVVISGCRPKYF-NIEG-ADIGITSDDLFPLASVPGK : 203
Fruitfly : EDWHRDVRVSVGNHKSNNWVTRVLDTRDKKVEYINGLGSFVLSF--TLLAKLRSE-ERTITACTFVIVGGRPRYP-IIEGAVENGITSDDLFSDREPGK : 294
Mouse : HNWKTMABAVQNEHVKSLNNGHRVQICDRKRVYENIKASFVDEE--TVRCVLEKCKATLLSAEHTVIATGGRPRYPVTCVKGALEMGITSDDIIFLKESPGK : 220
Human : HDWRMABAVQNEHVKSLNNGHRVQICDRKRVYENIKASFVDEE--TVCCVAKGKREILLSDAHTIIATGGRPRYPVTEICGALEMGITSDDIIFLKESPGK : 220

Celegans : TLIVGCGYVLELCAGFLAFNQLVEVLVRSILKGFDRDCVHFVMEHLKTAGVVKKEHVEVEVEAAGS----KKKVTFTGNGGVEEYDTVIWAGRVE : 298
Fruitfly : TLVVGAGYIGLELCAGFLKIGLYEPTVMVRSIVLRGFDQCNAEIWAASMEERGIPFIRKTVLSVEKQDDGKLLKPKRVVTCGAEADVDYDTVLWAGRKG : 394
Mouse : TLVVGASVYVLELCAGFLTIGIGLDTVMVRSILVRGFDQMSSTVTEHMESEGTQLRGCVEVSEKPKLPTNQLQVTEEDHASGKEDTGTFTVLWAGRVE : 320
Human : TLVVGASVYVLELCAGFLTIGIGLDTVMVRSILVRGFDQMSMVHEHMASEGTRFLRGCASRVVRRIPDGQIQVTEEDS4TGKEDTGTFTVLWAGRVE : 320

Celegans : NLKSLNLDNAGVREDKRSGKIIIDFEFDRASCNGVYAVGDIVQDRCELTPLAIQSGKLLDRLRFSNSKQIVRFQGVRTTVFTPLELSTVGLTEEEAATQKHG : 398
Fruitfly : LVDDLNLPNAGVTVQKD--KTEVDSCEATINANIYAVGDIHYGKELTPVAVLGRLLRRLYCGSTQRMVYKVVVTVFTPLEYAGVGLSEEDAVKQEG : 492
Mouse : ETRTLNLEKAGISLNPKNKIIVDACEATSVPFIYAIGDVREGREELTPFAIKAGKLLARLFKESSTLMVYSNVFTTVFTPLEYAGVGLSEEDAVVARG : 420
Human : DARSNLNLEKAGVDSPTDCKIIVDSREATSVPFIYAIGDVVEGREELTPFAIMAGRLLVCRLEFGSSDLMVYDNPVFTTVFTPLEYAGVGLSEEDAVVARG : 420

Celegans : EDSIEVFHSEHFFEFYVFPQNKESGFCYVRFVGRDESDCKIIGLHFVGNAAEVHQQYAAFFRVGIGMSLQNTIPIHFCSSEEFVKLFTTKRSGQFPRT : 498
Fruitfly : ADEIEVFHGYHPEEFVFPQ-RSVRYCYLRFVAPRHGDCRVYGLHYIGFVAGEVHQQGPAARSRGLAINTLINTVGIHPHTAEEFTRLAITKRSGGLFP : 591
Mouse : CEHEVEYHAYYHPEEFVAG-RDASCCYIKVVCYREPEQCVLGLHFLGPNAGEVHQQGFAICIKGGSYACVMCTVGIHPHCSEEVVKLEISKRSGLFP : 519
Human : CEHEVEYHAYYHPEEFVAG-RDASCCYVNVVCIPEPEQCVLGLHFLGPNAGEVHQQGFAICIKGGSYACVMCTVGIHPHCSEEVVKLRIKRSGLFP : 519

Celegans : QCCCG : 503
Fruitfly : ASCCS : 596
Mouse : RGCUC : 524
Human : RGCUC : 524
    
```

B

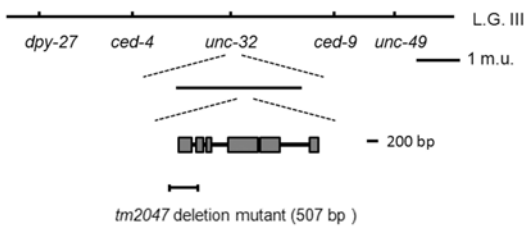

C

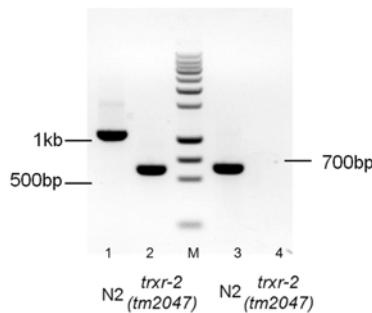

D

